

ELECTRO-PROPORTIONAL VALVES—PRESSURE CONTROLS

TS98-30 Proportional Electric Reducing/Relieving

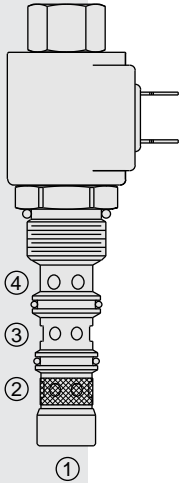

DESCRIPTION

A screw-in, cartridge-style, pilot-operated, spool-type reducing/relieving valve, which can be infinitely adjusted across a prescribed range using a variable electric input. Pressure output is proportional to DC current input. This valve is intended for use as a pressure control device in demanding applications.

OPERATION

Without applied current, the **TS98-30** allows bidirectional flow from ③ to ④ while blocking ②. When the coil is energized, ③ is connected to ②, and pressure at ③ is controlled proportional to the amount of current applied to the coil. If pressure at ③ exceeds the setting induced by the coil, pressure is relieved to ④.

Back pressure on port ④ becomes additive to the pressure setting at a 1:1 ratio.

Note: This product may be customized for special OEM performance characteristics. Consult factory.

FEATURES

- 12 and 24 volt coils standard.
- Optional waterproofed E-Coils rated up to IP69K.

RATINGS

Maximum Inlet Pressure at Port ②: 24 bar (350 psi)

Maximum Control Current: 0.70 amps for 12 VDC coil; 0.35 amps for 24 VDC coil

Deadband: 0.150 amps @ 12 VDC; 0.075 amps @ 24 VDC

Hysteresis: 3.0% PWM

Reducing/Relieving Pressure Range from Zero to Maximum Control Current: 0–20.7 bar (0–300 psi)

Rated Flow: 30 lpm (8 gpm) at 45 psid port ③ to ④ with coil de-energized

Maximum Pilot Flow: 0.4 lpm (0.12 gpm)

Flow Path: Free Flow: ③ to ④ bidirectional coil de-energized; Reduced: ② to ③ coil energized; Relieving: ③ to ④ coil energized; Port ① is not plumbed externally

Temperature: -30 to 175°C (-20 to 350°F), with standard Fluorocarbon seals

Filtration: See page 9.010.1

Fluids: Mineral-based or synthetics with lubricating properties at viscosities of 7.4 to 420 cSt (50 to 2000 sus); See Temperature and Oil Viscosity, page 9.060.1

Installation Recommendation: When possible, the valve should be mounted below the reservoir oil level. This will maintain oil in the armature preventing trapped air instability. If this is not feasible, mount the valve horizontally for best results.

Cavity: VC98-3; See page 9.110.1; **Cavity Tool:** CT98-3XX; See page 8.600.1

Seal Kit: SK90-3V; See page 8.650.1

Coil Nut: Part No. 7004410;

For E-coils manufactured prior to 1-1-04, see page 3.400.1 for coil nut info.

SYMBOLS

USAS/ISO:

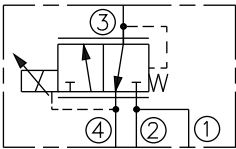

PERFORMANCE

Pressure Drop vs. Flow Characteristic For Flow ③ to ④ with Coil De-energized

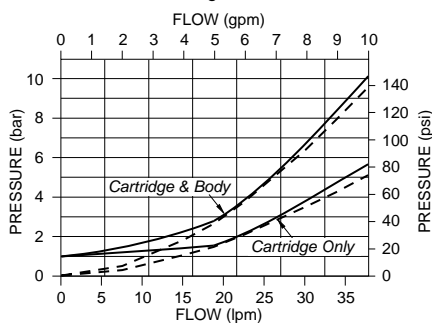

Reduced Pressure vs. Current Characteristic For a Regulated Pressure Range of 0–20 bar (0–300 psi) with Input Pressure at ② Control Current: 300 Hz

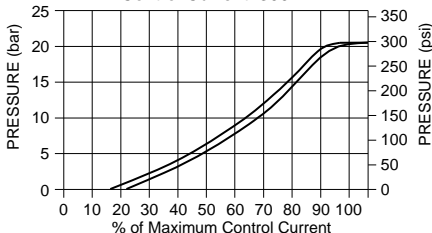

Reducing/Relieving Pressure vs. Flow Characteristic Regulated Pressure Range: 0–20 bar (0–290 psi) with 24 bar (350 psi) Input Pressure at ③ for Various Control Currents (ΔP Shown for Cartridge & Body)

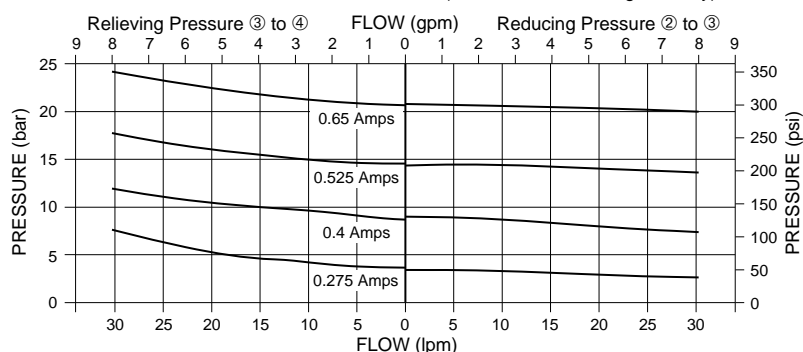

Performance info. continued on following page.

Valve w/Internally Piloted Spool

TS98-30

PERFORMANCE (continued)

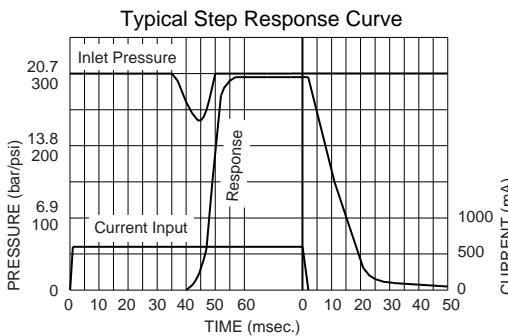
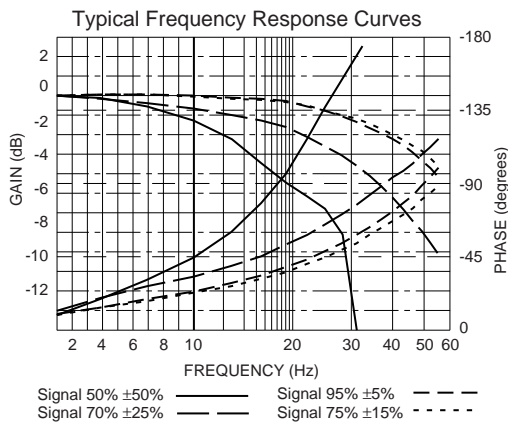

Recommended Electronic Controllers:
See page 2.001.1 or our Electronics catalog.

DIMENSIONS

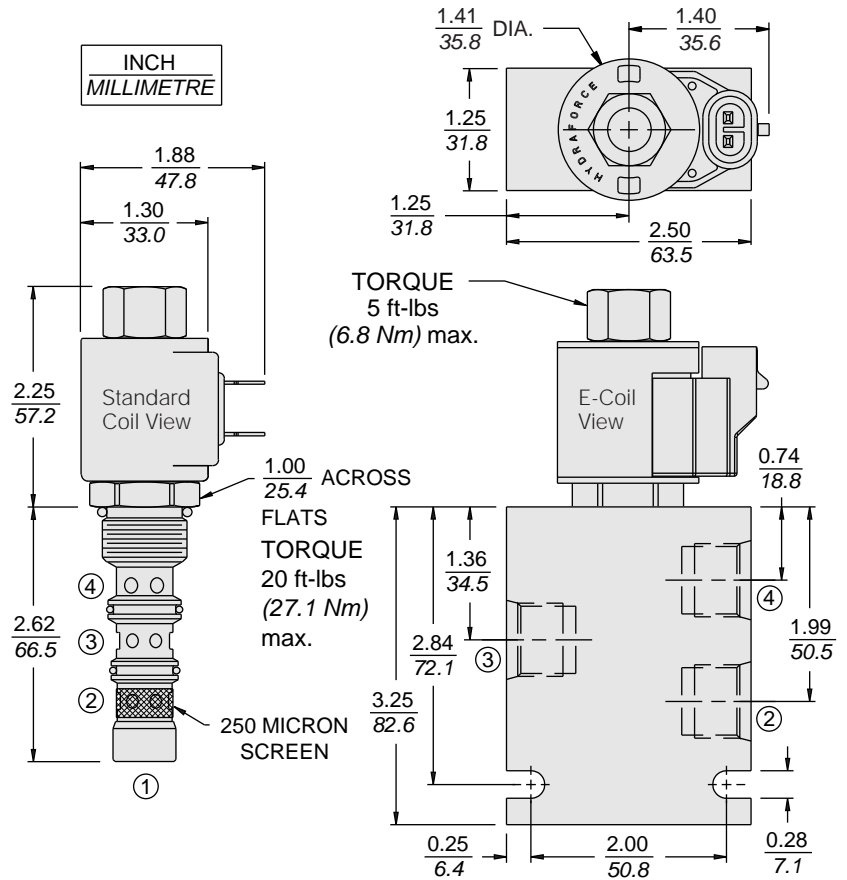

MATERIALS

Cartridge: Weight: 0.25 kg. (0.55 lbs.); Steel with hardened work surfaces. Zinc-plated exposed surfaces. O-rings standard.

Standard Ported Body: Weight: 0.34 kg. (0.75 lbs.) Anodized high-strength 6061 T6 aluminum alloy, rated to 207 bar (3000 psi). Ductile iron bodies available; dimensions may differ. See page 8.010.1.

Standard Coil: Weight: 0.27 kg. (0.60 lbs.) Unitized thermoplastic encapsulated, Class H high temperature magnet-wire. See page 3.200.1

E-Coil: Weight: 0.14 kg. (0.3 lbs.) Perfect wound, fully encapsulated with rugged external metal shell. Rated up to IP69K with integral connectors.

Note: See page 3.400.1 for all E-Coil retrofit applications.

TO ORDER

TS98-30 - - -		
Porting		Termination Std. Coil
Cartridge Only	0	DS Dual Spades
SAE 6	6T	DG DIN 43650
SAE 8	8T	DL Leadwires (2)
		DL/W Leads w/Weatherpak® Connectors
Seals		DR Deutsch DT04-2P
Fluorocarbon	V	Termination E-Coil
		ER Deutsch DT04-2P (IP69K Rated)
Voltage		EY Metri-Pack® 150 (IP69K Rated)
Less Coil	0	
10 VDC (0.84 amps max.)	10	
12 VDC (0.70 amps max.)	12	
20 VDC (0.42 amps max.)	20	
24 VDC (0.35 amps max.)	24	
Consult factory for other voltages		Coils with internal diode are available. Consult factory.